

My First Hamster Home 2-Story Assembly Instructions

DESCRIPTION	MATERIAL NO.	UPC
MFH Hamster 14" x 10" 2-Story	100513099	045125500226
MFH Hamster 2-Story, Unassembled	100037815	045125600292

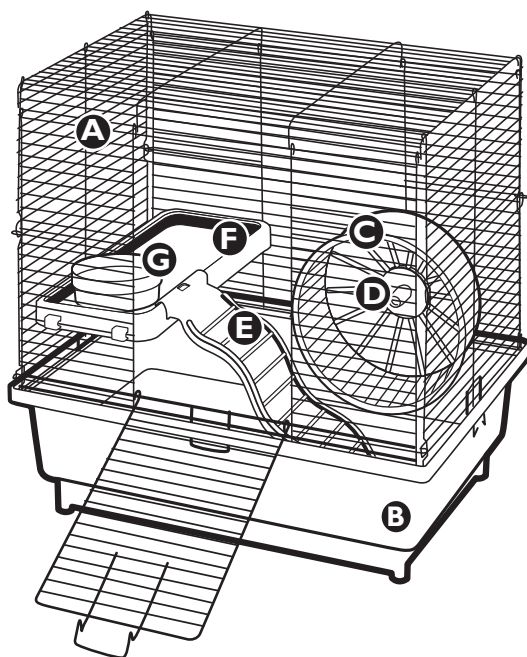

Important:

Carefully Unpack and Sort All Components on the Parts List

QTY.	KEY	DESCRIPTION
1	A	Wire Panel Set
1	B	Plastic Base
1	C	Wheel
1	D	Wheel Hub
1	E	Safety Ramps
1	F	Comfort Shelf
1	G	Food Dish

If your new pet home has experienced damage during shipping, please do not return your cage to the store. Our Customer Service Department is available to help with any problems. Our Toll-Free Number (within the USA and Canada only) is 800-255-4527, Monday - Friday from 8:00 a.m. to 4:00 p.m. (Central Standard Time).

SAVE YOUR INSTRUCTIONS FOR FUTURE REFERENCE

STEP 1 Unwrap Wire Panel Set

Unwrap the Wire Panels (A) and lay on a flat surface with the doorway facing upward.

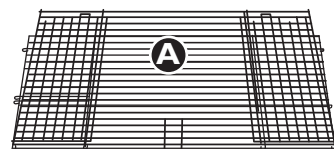

STEP 2 Unfold Wire Panel Set

Carefully unfold the Front, Back, and Side panels.

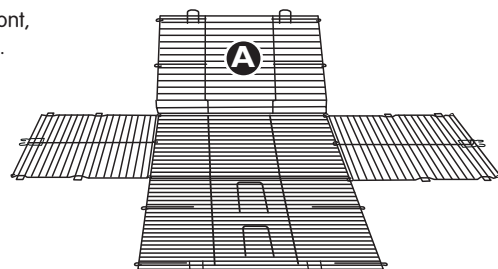

STEP 3 Lock Side Panels to Back Panel

Lock the Right and Left Side Panels onto the Back Panel.

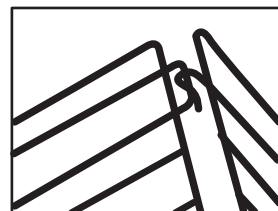

Snap the wire hook through the wire loop.

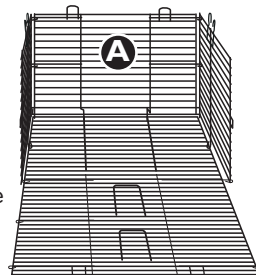

STEP 4 Lock Front Panel to Side Panels

Next lock the Front Panel onto the Side Panels.

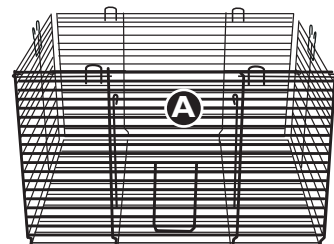

Special Note: If the wire hooks have become bent during shipping, carefully pry them open to fit into the side panel wire loops.

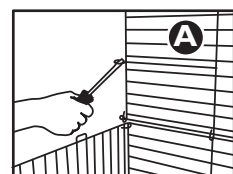

STEP 5 Insert Wheel Hub into Wheel

Insert the Wheel Hub (D) into the center of the Wheel (C) until it locks into place. Insert the "E-Z" Twist Handle of the Wheel Hub between the 3rd and 4th bar from the bottom of the back wire panel. Twist the Wheel Hub until it is vertical and the Wheel is locked in place.

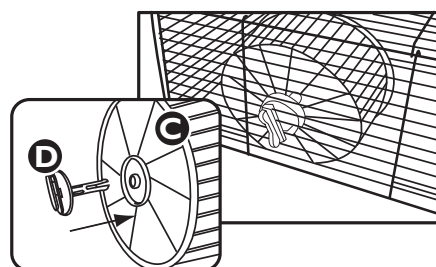

STEP 6 Lock Wire Panels into Base

Place the wire cage on top of the Plastic Base, making sure to insert the wire tabs into the slots in the base.

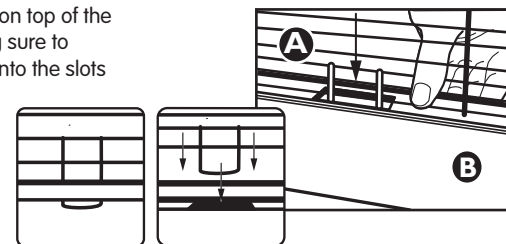

STEP 7 Secure Wire to Base

Line up the loops at the bottom of the Wire Panel Set (A) to the holes provided on the Plastic Base (B).

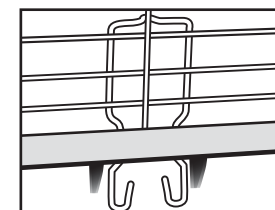

STEP 8 Put in Comfort Shelf

Position the Comfort Shelf (F) with Opening on the 7th full-length wire bar up from the bottom on the left hand side, with the opening toward the rear of the home. Press down so that the shelf locks firmly in place.

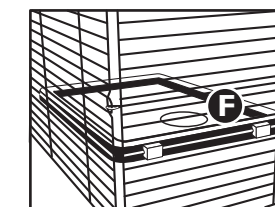

STEP 9 Clip on Safety Ramp

Clip the Safety Ramp (E) to the Comfort Shelf (F) by snapping the two prongs on the Ramp to the edge of the Comfort Shelf.

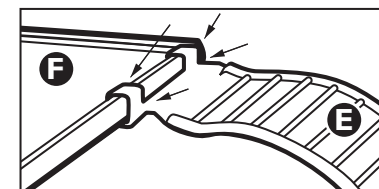

STEP 10 Insert Food Dish

Place the Food Dish (G) in the opening on the Comfort Shelf.

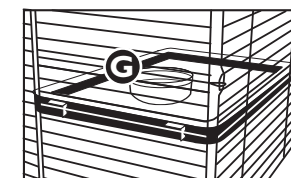

SAFETY

To safely secure your pet inside the home, firmly press the "Z-Lock" Latch behind the 2nd horizontal cage bar above the door opening.

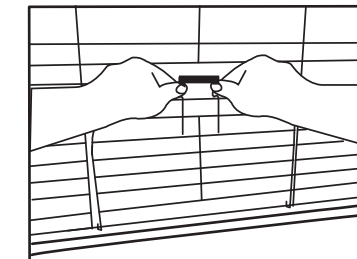

CLEANING

Pinch Bunny Ear latches on each side of the Wire Set (A) and lift the entire Wire Set off the Plastic Base (B). Set the assembly on a flat surface while you empty the Plastic Base (B). Empty and wash the Plastic Base (B) with soap and water or spray with Kaytee® Clean Cage (Item #100079553) (sold separately), and wipe dry. Kaytee® Clean Cage neutralizes odors, safely cleans surfaces and is non-toxic to all pets.

